

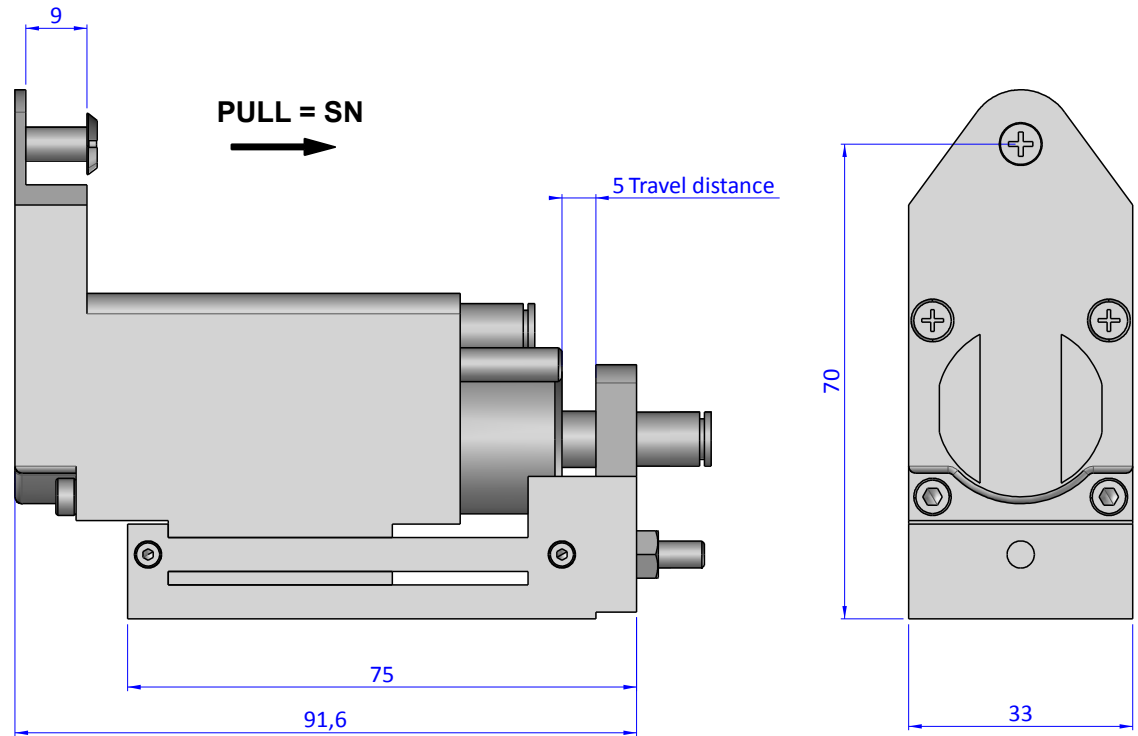

THE PROPERTY OF THE DRAWING IS ESTABLISHED BY LAW. IT IS FORBIDDEN TO PRODUCE OR SHOW IT TO THIRD PARTY, WITHOUT A WRITTEN AGREEMENT.

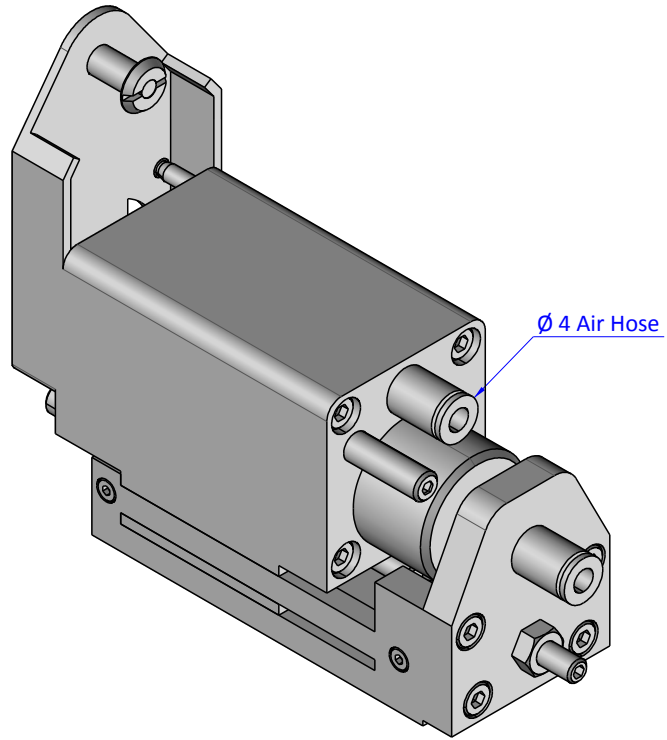
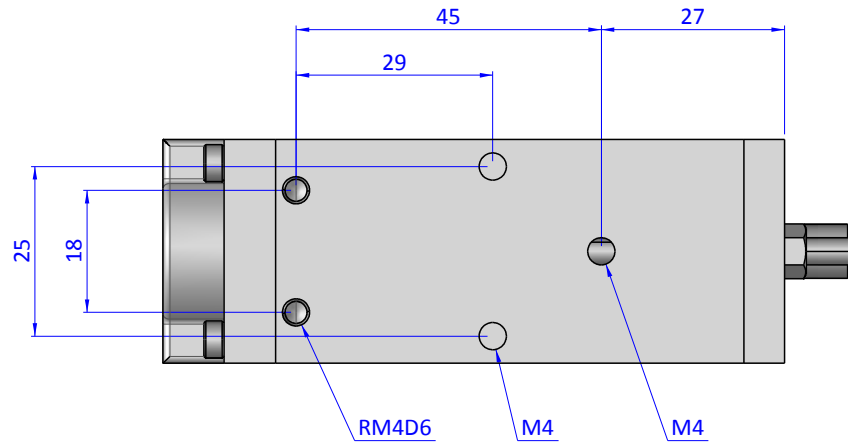

Format A3

UNI 936-76

 FPS FPSERVICES AUTOMATION		DESIGNED FROM		REVIEW
		FPS Automation		A
GENERAL TOLERANCE		DATE	WEIGHT	
UNI - ISO 2768		20/09/2018	0,300Kg	
CLASSE f		CODE		
		CA.SN10		CA.SN10